



FOBO Bike

User Manual

Version 2.6

(For iOS7.1 and Android 4.30 & above)

Contents

- 1 Introduction**
- 2 About FOBO Bike**
- 3 Importance of tire care**
- 4 Product Description of FOBO Bike**
 - 4.1 Tire Sensor unit**
 - 4.2 Sensor lock nuts & wrench**
- 5 Using FOBO Bike**
 - 5.1 Installing FOBO Bike App**
 - 5.2 Installing FOBO Bike sensors**
 - 5.3 Setting up multiple users(FOBO Share)**
 - 5.4 Tire rotation**
 - 5.5 Disable sensor and Replace new sensor**
 - 5.6 Release and Uninstall FOBO Bike**
 - 5.7 Transfer FOBO Bike to another user**
 - 5.8 Changing Recommended Tire Pressure**
 - 5.9 Show/Hide Recommended Tire Pressure**
 - 5.10 Clear Memory**
 - 5.11 How to change Bike profile picture**
 - 5.12 How to turn on Gage pressure**
 - 5.13 How to Turn on FoboSignal +**
 - 5.14 Tire Inflation/Deflation**
 - 5.15 Reference pressure at 20 deg C**
 - 5.16 Overlay service**
- 6 FOBO Bike Alert Messages**
- 7 Replacing Battery**
- 8 Trouble Shooting Guide**
- 9 FOBO Bike Specifications**
- 10 Warning**

11 Regulatory Information

12 Intellectual Properties

13 Limited Warranty and Disclaimer



1 Introduction

FOBO Bike is the world's most advanced Tire Pressure Monitoring System (TPMS) using Bluetooth Smart (Bluetooth 4.0) technology to monitor your 2, 3 or 4 wheelers tire pressure and temperature. Bluetooth Smart is a very low power wireless technology that could operate on a single coin cell battery for up to two years (**NOTE: Battery life may vary according to usage and climatic temperature. Operating under extreme cold may drastically reduce battery life.**)

Please ensure that your smartphone has Bluetooth Smart Ready (Bluetooth 4.0) capability in order to use FOBO Bike. Currently FOBO Bike works best with iOS7.1 and Android 4.3.0 and above.

Before starting to use FOBO Bike, please download the free FOBO Bike App to your smartphone from Google Play Store or Apple AppStore.

FOBO Bike is a product designed and produced by Salutica Allied Solutions Sdn. Bhd. ("Salutica"), a Malaysian company with its address at No. 3, Jalan Zarib 6, Kawasan Perindustrian Zarib, 31500 Lahat, Ipoh, Perak, Malaysia.

2 About FOBO Bike

FOBO Bike monitors your bike tires non-stop around the clock. Most riders have encountered situations where they need to rush for an urgent appointment only to be stranded by a flat tire. A conventional Tire Pressure Monitoring Systems (TPMS) for bikes could not alert you in advance conveniently because it requires the use of a separate receiver. With FOBO Bike, you will get an alert as soon as the tire pressure drops below a certain pre-set level and as long as your smartphone is within the Bluetooth range (~30m). This alert gives you time to get the deflated tire fixed before you need to use your bike.

The FOBO Bike system consists of 2 tire sensors, and the FOBO Bike App. It requires a smartphone and the FOBO Bike App for installation.

Replace your tire valve caps with the FOBO Bike tire sensors and pair them according to the App's simple on screen instruction. **NOTE: Under certain conditions the signals from FOBO Bike sensors may be blocked by surrounding objects or structures. If this occurs, please move around the vehicle in order to capture signals from all the tire sensors.**

The sensors will measure tire pressure of each tire and transmit via Bluetooth to your smartphone. In the event of a problem with your tire pressure or temperature, the FOBO Bike App on your smartphone will alert you.



FOBO Bike can monitor up to 9 bikes (or 18 wheels) on one smartphone. You will receive data from the tire pressure sensors for all your bikes through a touch of your finger.

If you are sharing your bike with family members or friends, you can allow others to access your FOBO Bike with permission through the FoboShare function. With FoboShare, the other user just needs to download the FOBO Bike App. After adding them through FoboShare, family members or friends using your bike will receive alerts and data from your FOBO Bike on their own smartphone immediately.

DISCLAIMER: FOBO BIKE IS NOT A DEVICE THAT PREVENTS ACCIDENTS. IT IS ALSO NOT A DEVICE THAT PREVENTS TIRES FROM BECOMING DEFLATED OR OVERINFLATED. FOBO BIKE IS NOT A SUBSTITUTE FOR SAFE TIRE MAINTENANCE PRACTICES. PLEASE CONTINUE TO TAKE PRECAUTIONARY MEASURES WHILE RIDING AND TAKE FULL RESPONSIBILITY OF YOUR VEHICLE'S TIRE CONDITION TO ENSURE SAFETY WHILE RIDING. YOU SHOULD CONTINUE TO PRACTICE PROPER TIRE CARE AND SCHEDULED TIRE MAINTENANCE.

3 Importance of Tire Care

It is extremely important to ensure bike tires are properly inflated for safety while riding. However, many riders tend to neglect proper tire care and maintenance. The bike tires are the only contact points between the bike and the road. The weight of the bike and rider are supported by the air pressure inside the tires. Improperly inflated bike tires may cause serious accidents on the road.

When bike tires are underinflated, a rider may feel instability while taking a corner or lack of response when maneuvering the bike. On top of that, underinflated tires reduce the bike's braking distance. The additional rolling resistance may cause build-up of heat which may lead to the de-lamination of the tire materials as well as damage to the tire's sidewall thus increasing the chances of a tire blow-out. Underinflated tires will also cause accelerated wear on the tire and also uneven tire wear. Gas mileage will also be affected due to additional rolling resistance when riding with underinflated tires.

On the other hand, an overinflated bike tire will cause accelerated wear on the center portion of the tire resulting in uneven tire wear. It would also result in a harsher ride and makes the tire more susceptible to damage when going over potholes or debris on the road.

What is the optimum tire pressure? There are a lot of information about this subject in internet forums and web articles. A quick guide for better understanding of tire pressure below:-

- 1) Bike manufacturers recommend the optimum tire pressure for their bike models. They may recommend different tire pressure for front and rear tires so please follow the recommendation in the bike user manual. These recommended pressures usually meant for comfort riding and optimum performance of the bike. It is not advisable to go below the recommended pressure level.
- 2) The bike manufacturer recommended tire pressure is “cold pressure”. When you ride your bike to the gas station, the friction on the road will heat up your bike tires within a few minutes. Typically there will 1 psi (~7kPa) increase in air pressure for every 10 deg F (5.6 deg C) rise in temperature, and vice versa for decrease in air pressure. It is advisable to inflate the tire pressure with this compensated pressure above the recommended pressure.
- 3) Air pressure in tires is affected by changes in temperature. Check and adjust your tire pressure whenever there is a drastic change in environment temperature, eg. change of seasons.
- 4) A tire will normally lose its pressure through natural causes unless accelerated by a puncture, faulty valve or damaged wheels. It is advisable to change the tire valves or at least check the valves condition every time you change a new set of tires. Under normal condition, a set of tires could deflate at a rate of up to 2psi per month. It is good practice to check your tire pressure regularly and top up to the optimum pressure.
- 5) Every bike tire has a maximum inflation pressure. It is not advisable to inflate to the maximum inflation pressure of the tire. Follow the bike manufacturer’s recommended tire pressure instead.

4 Product Description of FOBO Bike

4.1 Tire Sensor Unit

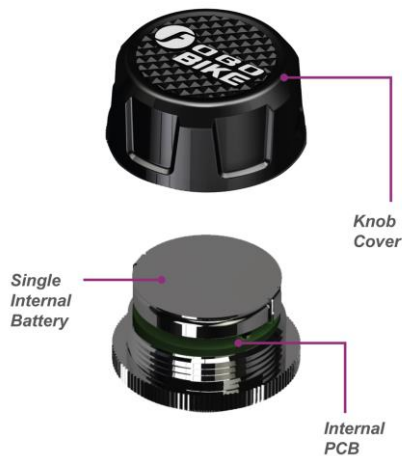

- Knob cover** - waterproof cover. Please ensure the red silicon ring is intact to prevent water from getting into electronics compartment.
- Single internal battery** - CR2032 coin cell battery. When replacing battery, please ensure the “+” sign of the battery is facing up, away from PCB.
- Internal PCB** - internal electronics circuit (The pressure sensor chip is mounted within this PCBA, and it senses the tire pressure against a built-in vacuum, resulting in an Absolute Pressure reading. The internal firmware will then subtract the sea-level pressure of 101.3 Kpa (14.7 psi) from this reading. This final reading which will be shown in the app can be termed as i) Tire **Absolute Pressure minus sea level pressure**, or ii) Gage Pressure reference to sea-level altitude. With this formulation, Fobo Bike sensor will read the same pressure value for any given tire, irrespective of altitude (assuming a constant temperature). This will ensure the correct tire footprint per vehicle manufacturer’s pressure recommendation, for all altitude above sea-level, given a constant temperature.



As a corollary, a tire with a Fobo reading of, say 40 psi at an altitude of 5000ft, will read the same 40 psi when driven to sea-level, given a constant temperature. In reality, it will read higher due to the warmer temperature at sea-level, and may need some air release if the temperature difference is great. Tire pressure generally will increase 1 psi (~7kPa) for every 10 deg F (5.6 deg C) rise in temperature.

Fobo wishes to highlight the above formulation is for usage at sea-level and above, and will not be accurate for use otherwise. In practice, this should not be an issue as the lowest area on earth will result in an insignificant error of 0.3 psi (~2 Kpa).

For users who wish to retain 'Gage Pressure Reading', the Fobo bike App has a Gage Pressure, adjusted to local altitude using cell towers or individual phone barometer if available. This Gage Pressure button can be accessed from the App (Kindly refers to Section 5.12 of this user manual).

FOBO Bike sensor units are designed to be robust and operate reliably 24x7 to provide tire information around the clock. It is designed to be water proof (IP57) and by our special use of custom engineering plastics, it will be able to withstand road salts or other common automotive chemicals (petrol, engine oil, bike wash shampoo, etc).

Our designers have designed the sensors to ensure that there is no air leakage as it replaces the tire's original valve cap. There is no need to screw on the sensor extremely tight. Apply a reasonable hand twist force to ensure the sensor is securely installed and should be able to be removed by hand with ease.

Note that the sensor position is fixed during installation. When installing the sensors, please follow the on-screen prompt of the FOBO Bike App. Do not screw on the tire sensors until instructed by the FOBO Bike App. After installation, in the event the tire sensors positions are mixed up, usually after performing a tire rotation maintenance, you can easily re-position the sensors to their correct position by selecting 'Rotate Tires' on the FOBO Bike App and follow the on-screen instructions. This eliminates the need to remove the tire sensors physically.

A missing or damaged tire sensor can be replaced easily procedure, through the FOBO Bike App. You will need to purchase a replacement sensor which you can do so online at www.my-fobo.com. To replace the sensor, first select 'Disable/Install Sensor' on the FOBO Bike App on your bike status settings and the App will

prompt you to tap on the tire position that you want to replace for 5 seconds. The box will then show “Disabled”. Then, select ‘Disable/Install Sensor’ again and tap on the same box and the App will prompt you to install the replacement sensor. Follow the on-screen instruction and the replacement sensor will be paired and ready to use.

NOTE: Battery life span up to Two years is an estimate based on normal use at 23 °C. Battery life may vary according to usage and climatic temperature.

Battery life span will change due to the following reasons:

- 1) Frequent change of pressure threshold setting in the App.**
- 2) Disabling & enabling of sensors.**
- 3) Release & pairing.**
- 4) Removal & screw-on of sensors.**
- 5) Operating under extreme cold/hot temperature.**
- 6) Testing of product.**
- 7) Rotation (refer section 5.4 of this user manual)**
- 8) Trigger alert or let activated alerts unattended.**
- 9) Multiple removal and screw-on of sensors for equalizing all tire pressures.**

All these activities will drain a battery very fast and affect the battery life span.

4.2 Sensor Lock nuts and wrench



FOBO Bike sensors are tied to a FOBO account after installation. They are not reusable or transferable without the owner releasing them from his/her FOBO account. This is a theft deterrent feature to discourage theft.

As an additional anti-theft feature, all FOBO Bike package comes with lock-nuts and a special wrench. FOBO Bike's functionality is not affected if you do not use the lock-nuts.

The lock nuts and wrench are made of custom engineering plastics that can withstand road salts and common automotive chemicals (gasoline, engine oil, bike wash shampoo, etc).

In order to use the lock nuts, you must first install the lock nut to the tire valve (with the bump facing tire rim). Screw in the lock nut all the way down and ensure that there is still a **minimum of 5 thread count** on the tire valve for the sensor unit to be screwed on. If there is insufficient thread for the tire sensor, it may lead to air leakage. A solution for this would be to change the tire valve to one with a longer thread. Next, screw in the tire sensor unit until it is reasonably tight. Then use your finger to unscrew the lock nut outwards (i.e. anti-clockwise) until it pushes against the bottom of the sensor unit. Use the wrench to tighten the lock nut. The resultant friction force will make it difficult to remove the sensor unit without loosening the lock nut. Hold the valve stem with one hand and tighten the lock nut with the wrench on another hand. This is to avoid the valve from twisting making it unable to tighten the lock nut.

WARNING: Do not apply too much force to tighten the lock-nut. You may face difficulty to loosen the lock nut.

NOTE: If your tire valve is too short, you shouldn't use the lock nut as this will block the sensors from being completely screwed on the tire valve and causes air leak. Our sensors are designed to work on a tire valve with a minimum of 5 thread counts.

Use the key chain provided to keep the wrench together with your bike keys, so that you don't have to worry about misplaced wrench when you need to remove the sensors when refilling air to your tires.

Step by step diagram to use FOBO BIKE Lock Nut and wrench

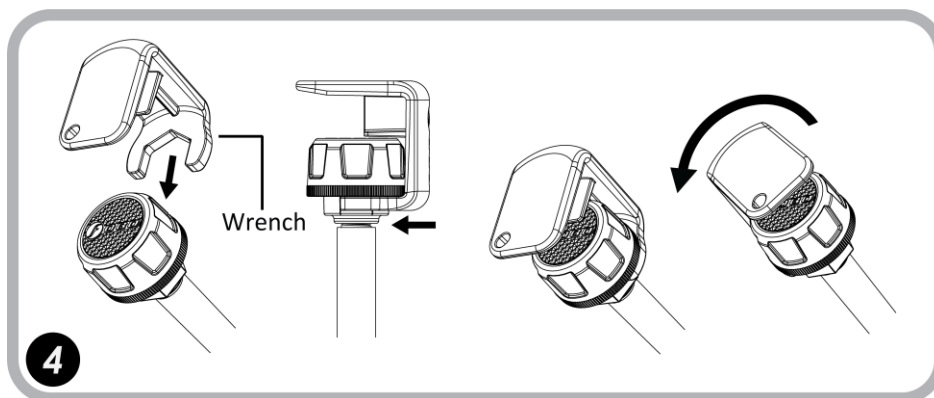
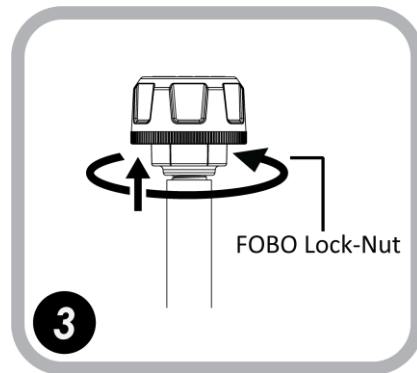
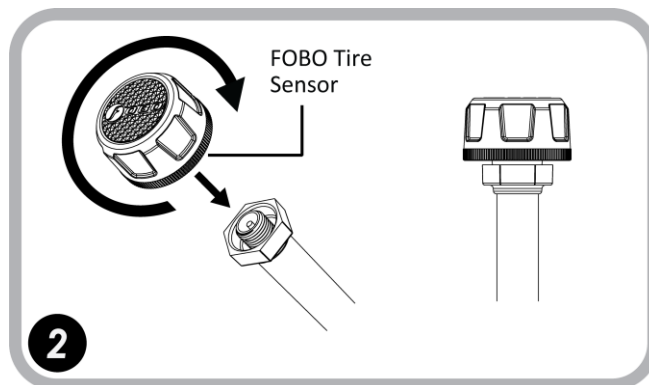
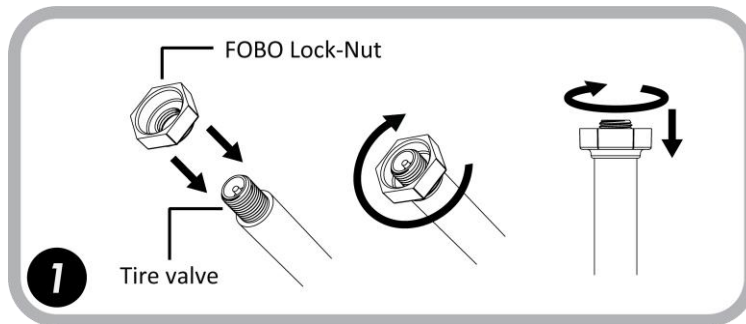

5 Using FOBO Bike

5.1 Installing FOBO Bike App

You are required to have a smartphone with **Bluetooth 4.0** (Bluetooth Smart) capability in order to use FOBO Bike. The smartphone must also be running on iOS 7.1 or Android 4.3 and above. Follow the steps below to install your FOBO Bike:-

Step 1: Download the FOBO Bike App onto your smartphone

- For iPhone users, download from Apple's AppStore. For Android users, download from Google Play. Search for "FOBO Bike".

Step 2: Launch the FOBO Bike App & key in your email address

- For new users, key in your email address and click login.
- You will receive an email from FOBO with an activation link.
- Click on the activation link that you receive in your email.
- Once activated, go back to the FOBO Tire App and click on login again.
- You be brought to the App's Home screen.

Note:

- An activation e-mail message will be sent to your e-mail address when you click on login as a first time user.
- If you do not receive this activation e-mail from FOBO Admin, please check your e-mail address entry to ensure it is valid without typo error.
- This e-mail may also be filtered by some e-mail servers. Please check your Spam mailbox.
- If you still do not receive any message from FOBO Admin after 15 minutes (with a good internet connection), please write in to fobo@salutica.com.my with your sign-in email.

IMPORTANT:

The email activation is to ensure that your account signup is done securely. FOBO Bike is locked to your FOBO account as an anti-theft deterrent. Stolen sensors cannot be used by anyone else other than the FOBO account owner.

Location service is required to be enabled for the FOBO Bike App (FOBO Bike does not use the GPS function to track your location). The location service on the iOS/Android system has other functionality that the FOBO Bike App uses to operate properly. It will ensure FOBO Bike functions as designed, mainly for alert functions, and also for the gauge pressure feature to work as required by users living at high altitudes. FOBO Bike is designed to be a low energy system and does not drain your smartphone battery excessively.



By submitting your information to sign up a new user account, you acknowledge your acceptance to the terms and conditions of our Software Licensing Agreement and Privacy Policy.

5.2 Installing FOBO Bike sensors

NOTE:

Do not install the sensors to the bike tire valves until prompted by the FOBO Bike App's on screen instruction.

To minimize the risk of potential electrostatic discharge (ESD) attack, please hold the tire rim when screwing the sensors on to the tire valves. ESD may cause damage to the sensor or impair its function.

Installing FOBO Bike sets on more than one bike which are closely parked may cause cross interference to the Bluetooth signals. Please install FOBO Bike on one bike at a time.

WARNING!

Please ensure sufficient clearance between installed FOBO Bike sensor and any part of the bike. There is a risk of damage to the sensor or ripping off valve from the rim or sudden air leak if clearance is insufficient; the valve may deflect under strenuous vibration.

Ensure sensor clearance with vehicle parts is 10mm (1/2") and 5mm (1/4") for installation on a rubber valve and a metal valve, respectively.

While FOBO has been advising FOBO users to inspect and ensure good state of rubber valves, some users find it difficult to determine so. Given that the structure of rubber valves degrade over time and over travelled distance, use of sensors on such rubber valve can cause a leak or tire blowout that leads to a sudden loss of control of the vehicles which subsequently leads to an accident and serious injuries. For the safety of all users, FOBO strongly recommends use of sensors only with metal valves. If users choose to use rubber valves, users must regularly check if the valves are fit to use. FOBO is not liable for any untoward consequences.

We highly recommend using Metal valves; T-valves and short metal valves are available on our web-store. Follow the below link to purchase:

https://my-fobo.com/Store#tab_FOBOACCS

To begin using FOBO Bike, firstly ensure that the FOBO Bike App is downloaded and you have already login to the App (see section 5.1 above for installation and login).

Follow the steps below to pair FOBO Bike to your smartphone:-

- 1) Turn on your smartphone's Bluetooth connection.
- 2) Open the FOBO Bike App.
- 3) Click on the "+" sign on the FOBO Bike App HOME screen to add a bike to your profile.
- 4) Choose a bike profile and click "Confirm". You have 11 options of bike profile to choose, such as below:-



- 5) Follow the instruction on the screen.
- 6) Key in the name you would like to identify your bike.
- 7) Tap on the profile picture box and take a picture of your bike.
- 8) Select the bike manufacturer recommended tire pressure for the front and rear tires.

Refer to the bike owner's manual for the recommended tire pressure. You cannot proceed with the pairing without the input of this information into the FOBO Bike App.

- 9) Click "Done" on the top right hand corner of the screen.
- 10) Next, you will be prompted to install the tire sensors. Follow the instruction on the screen. Screw the FOBO Bike tire sensor on to tire valves only when you are prompted. Make sure your smart phone is nearby or touching the sensor to detect signal from the sensor unit. If you had screwed in the sensor before instructed by the App, remove the sensor completely and screw it back in again. Repeat with subsequent sensor, starting from the Front-Right tire.
- 11) You will be prompted that installation is completed and you are now ready to use FOBO Bike.



CAUTION:

Motor vehicles of all kinds (cars, trucks, motor scooters and motorcycles) come with a very wide array of rims, wheels, and tires, with an even larger choice of aftermarket products. It is impossible for us to test every combination and check the fitment of the FOBO sensor. In some instances, when the FOBO sensor is screwed onto the valve stem, it might extend slightly beyond the face of the rim/wheel. If the rim/wheel comes close to or strikes an object, such as a curb, a pothole, the guide rail for an automatic car wash, or a component on the vehicle (such as the brake system on a motorcycle), the FOBO sensor or the valve stem itself might become damaged. This can cause the FOBO to provide improper readings, or might cause a loss of air pressure. We recommend that you carefully assess the fitment of your rims, wheels, tires and the FOBO on your vehicle. If you have any concerns, consult with your tire shop or auto mechanic. A shorter valve stem might be considered to mitigate the situation.

5.3 Setting up multiple users(FOBO Share)

FOBO Bike is easy to share with your family members and friends. You can share FOBO Bike with up to 100 users by using the App's FoboShare function. All that is required is that these other persons download the FOBO Bike App (they will also need an iOS/Android smartphone with Bluetooth 4.0 that is running on iOS7.1 or Android 4.3 and above). They need to activate their App with their email and login to the App.

Follow to these steps to share your FOBO Tire with other users:-

1. Ensure that the user to be shared (recipient) has downloaded the FOBO Bike App and has activated their App with their own email address.
2. Ensure that the recipient's smartphone has the Bluetooth connection turned on.
3. On your bike status screen, click on the settings icon and select 'FoboShare'.
4. Click on the "+" sign at the top right corner of the App.
5. Type in the recipient's email address that was used to activate the App.
6. Your bike profile will appear on the recipient's App with a "FoboShare" logo.
7. The recipient clicks on your bike profile and will start to receive all the data from your FOBO Bike sensors on his/her smartphone when he/she is within Bluetooth range.

NOTE: Please ensure good internet connection for FOBO Bike App to connect to the cloud.

Note that shared users will not be able to change settings (name, user limits, etc) on your FOBO Bike profile using their phones. They can only view the readings and receive alerts. At the FOBO Bike's App HOME page, a shared bike will depict a "FoboShare" logo at the bottom of bike profile image to distinguish a shared bike from your own bike.

5.4 Tire rotation

This feature is useful when you have sensors that mixed up and you are not certain which sensor goes to which tire position. It is used to set the sensor to their new positions.

You do not need to physically remove the sensors. To correct the position of the sensors in the FOBO Bike App, please select Tire Rotation in bike status screen. You will be prompted by the App to:

- 1) Move to the tire position instructed by the App.
- 2) Place your phone touching the sensor and hold it there for 15 seconds.
- 3) Repeat step 1 & 2 for remaining tire position as instructed by the App.

You are now ready to use FOBO Bike with the new tire positions. You can perform tire rotation as often as you want.

5.5 Disable sensor and Replace new sensor

You may want to disable a sensor in the App due to a physically missing sensor or damaged sensor and to install a replacement sensor. Disabling the missing or damaged sensor in the App will stop the alert for missing sensor alerts.

To disable a tire sensor:-

1. Select “Disable/Install Sensor” at the bike status screen setting.
2. Long press the box corresponding to the tire position you want to disable until a prompt message appears in 5 to 10 seconds. Due to variation in phone models, glass surface and finger conditions, the prompt message may take longer to appear or may not appear. Please readjust finger position and long press again.
3. Click OK on the message box to disable the sensor.
4. You will see “Disabled” inside the box corresponding to the disabled tire position, the box will be greyed out too. Take note that FOBO Bike will stop monitoring tire for a disabled sensor position.

To install a replacement tire sensor:-

1. Select “Disable/Install Sensor” at the bike status screen setting.
2. Long press the box corresponding to the tire position you want to install until a prompt message appears in 5 to 10 seconds. This would be the box with the text “Disabled” for the sensor that you had previously disabled.
3. Click OK on the message box to install the sensor. You will be prompted to screw on the sensor to the tire valve and hold your smartphone touching the sensor.
4. You will be prompted that the sensor has been successfully installed and you can immediately use it.

NOTE: You can only install a replacement sensor after the tire position has been “Disabled”. You can purchase replacement sensors online from www.my-fobo.com.

5.6 Release and Uninstall FOBO Bike

To release and uninstall FOBO Bike, do the following steps:-

1. At the Home screen, select the Bike that you want to uninstall/release.

2. Tap the settings icon at the top left of the screen.
3. Select “Release Bike Sensors” and follow the instruction on the screen.
4. You will see “Released” in the corresponding boxes of the released sensor.
5. Repeat step 2 to 4 for the remaining sensors.
6. After all the corresponding boxes are shown “Released”, go back to the home screen.
7. Swipe right to left on the Bike profile that you wish to remove and click on ‘Delete’ which will appear after you swipe.

NOTE: Do not delete your Bike profile before releasing the sensors. If you have accidentally done so, re-install the sensors to the same FOBO account and follow the release procedure above to properly release the sensors.

5.7 Transfer FOBO Bike to another user

Before passing on your FOBO Bike set to another user, you will have to release the FOBO Bike sensors from your FOBO account. Follow the instructions at Section 5.6 above to release your FOBO Bike sensors.

Note: If a unit is to be used on another vehicle but by the same user, there is not a need to re-install, user just needs to unscrew the sensors and screw back on another vehicle tire valve. User can choose to do tire rotation if he/she not sure about the tire position (Refer to section 5.4 of this user manual).

5.8 Changing Recommended Tire Pressure

CAUTION:

Do not change setting when away from your bike. Once you have confirmed a changed of settings on your FOBO Bike App, you will be prompted to sync the new settings with the sensors by the following the FOBO Bike App’s pop-up instructions.

To change your bike tire pressure setting:-

1. Select the Bike profile that you wish to change its settings.
2. At the Bike status screen, click the settings icon at the top left of the screen to call up the Setting Menu.
3. Then select “Edit Bike Profile”.
4. At the bottom of the ensuing screen, the current pressure settings of tires are shown. Tap at the tire that you would like to change its setting and 3 scroll wheels will Appear for:-

Min – Minimum Pressure threshold.

Recommended – Bike manufacturer recommended tire pressure.

Max – Maximum Pressure threshold.

5. You will only need to scroll the middle wheel labeled ‘Recommended’.
6. Scroll the recommended pressure to the value that you wish to set. The other ‘Min’ and ‘Max’ scroll wheels will automatically change based on the ‘Recommended’ pressure that you have set. The ‘Min’ value is automatically set 8% below the ‘Recommended’ pressure and the ‘Max’ value is automatically set 25% above the ‘Recommended’ pressure.
7. If you wish to customize the ‘Min’ and ‘Max’ values, you can scroll them independently. The App limits the customization of ‘Min’ and ‘Max’ values to 15% below (or 30kPa whichever is higher) and 35% above (or 600kPa whichever is lower) the ‘Recommended’ pressure, respectively.
8. Click on ‘Done’ and you will be prompted by the App to sync the settings with the sensors.
9. Follow the on screen instructions to sync the settings.

Note: The Min value cannot be set higher than the selected Recommended value while the Max value cannot be set lower than the selected Recommended value.

5.9 Show/Hide Recommended Tire Pressure

You can choose to display or hide the Bike Recommended Pressure in the “Bike Status” Page by selecting ‘Show Pressure Setting’ or ‘Hide Pressure Setting’ from the bike status screen setting.

5.10 Clear Memory & Grey Out Reading Box

The most recent tire pressure reading will be displayed in the Bike Status screen whenever the phone and FOBO Bike are within Bluetooth connection range. These pressure readings will always be displayed as memory until the phone receives the next pressure reading update from FOBO Bike sensors.

User can clear the memory of tire pressure readings by selecting Clear Memory option in the bike setting screen. All relevant tire boxes in the Bike Status screen will be cleared and display “--” until the phone receives signal from FOBO Bike sensors.

The background of the pressure reading box will turn grey when your phone and sensors are out of Bluetooth connectivity zone (10-20m). The readings shown are the last memory. The background of the reading box will return to white when the Bluetooth connectivity is restored. It takes 10-15 sec for each sensor to restore the signal, and depending on the timing, one may be grey and one may be white. Eventually all the boxes should be white before you start your journey.

This Function is normally used for trouble shooting purposes. FOBO Bike will always update the reading displayed on the App automatically with the latest reading. You do not need to select 'Clear Memory' to get the latest reading.

NOTE: If the grey boxes do not turn white when you are in the Bluetooth connectivity zone with the sensors, it may indicate a sensor problem. Please check if the sensor is missing, out of battery, or defective.

5.11 How to change Bike profile picture

- Long press on the default bike image, you will see a pop-up menu with 3 options:
 1. Image from camera.
 2. Image from library.
 3. FOBO image.
- Select your preferred option.

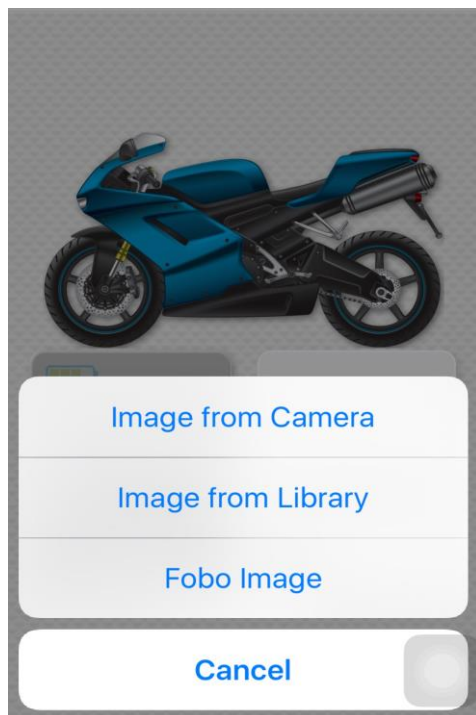

5.12 How to turn on Gage pressure

To turn on Gage pressure:-

- i. At the Bike Status screen, click the gear icon at the top Right corner.
- ii. Select “Enable Gage Pressure”.

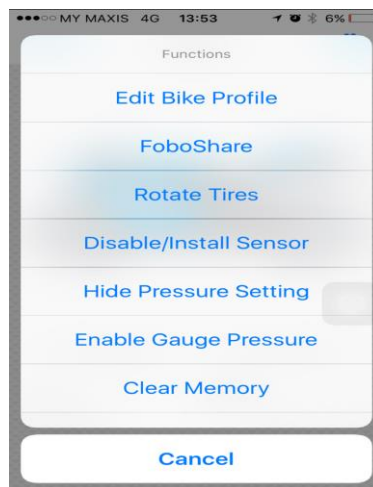

5.13 How to turn on FoboSignal +

To turn on FoboSignal +:

- i. At the Bike Status screen, click the settings icon at the top Right corner.
- ii. Select “FoboSignal+ on/off”.
- iii. Follow the instructions on the screen.

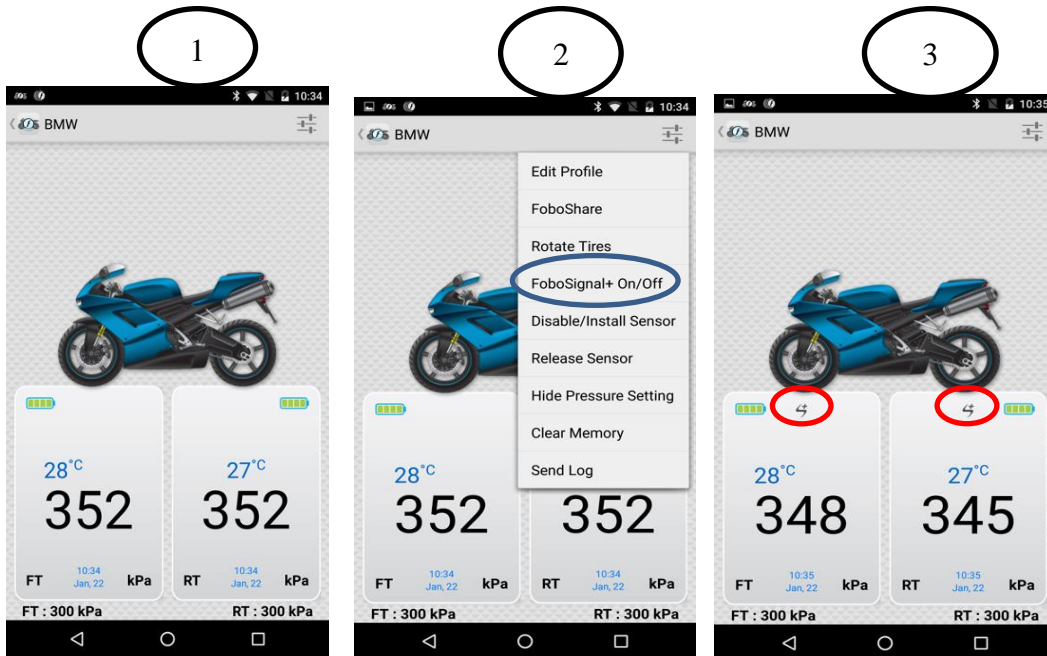

This feature will enhance sensor signal reception. It is useful if the Bike is pulling a trailer with installed FOBO Bike sensors or the user is facing a problem in receiving signals from the sensors due to interference.

For power consumption, use of FOBO Signal + may reduce the battery life by 25% to 30%. If your sensor range and signal is fine, then you don't need to use this feature.

5.14 Tire Inflation/Deflation

To Inflate/Deflate the tire user just need to unscrew the sensor, inflate/deflate the tire then screw back the sensor on tire valve. User does not need to release or disable the sensor.

5.15 Reference pressure at 20 deg C:

Reference pressure is a temperature-compensated tire pressure referenced back to a standard temperature of 20 degree Celsius. This is useful and serves as a guide for the user to decide on the approximate amount of air needed to inflate the tire during hot season or immediately after a long drive.

The reference pressure reading is located above/below the actual pressure reading in blue with smaller font size. The user has an option to show / hide the reference pressure reading for individual profile by going to the “settings” at top right corner.

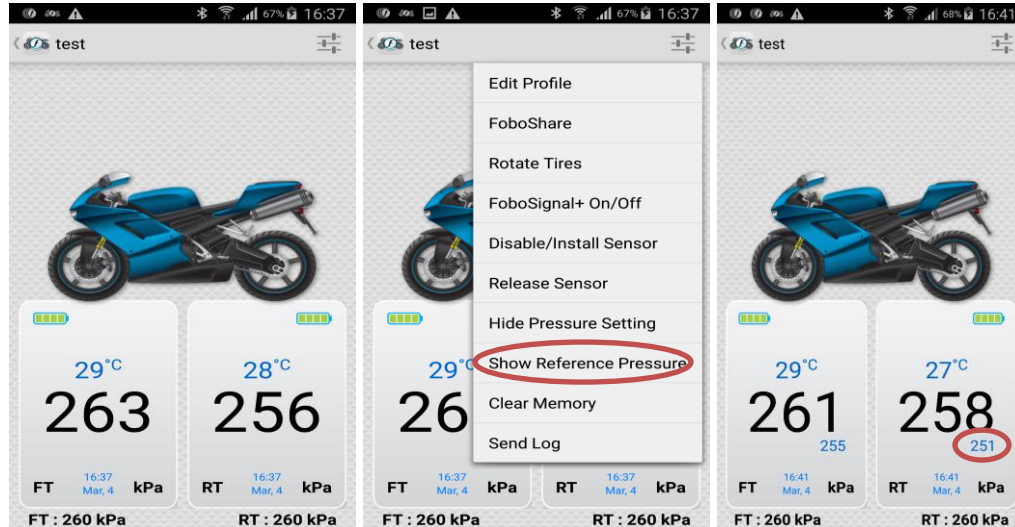

5.16 Overlay service:

“Overlay service” feature is an effective approach which helps the users to get the latest pressure, temperature and battery readings just by a single click on the FOBO overlay icon which is displayed on the mobile home screen without the need of going into the FOBO Bike App. Through this feature user can use any other App in the foreground with live FOBO readings displayed on the screen.

To turn on the Overlay Service:

1. Open the FOBO Bike App.
2. Click on the General settings (Wheel icon at top right of screen) on the HOME screen of FOBO Bike App.
3. Turn on the Overlay service under UI settings.
4. Upon turning on the Overlay service FOBO overlay icon will appear on the screen.
5. Click on the FOBO overlay icon to get the pressure, temperature and battery readings.

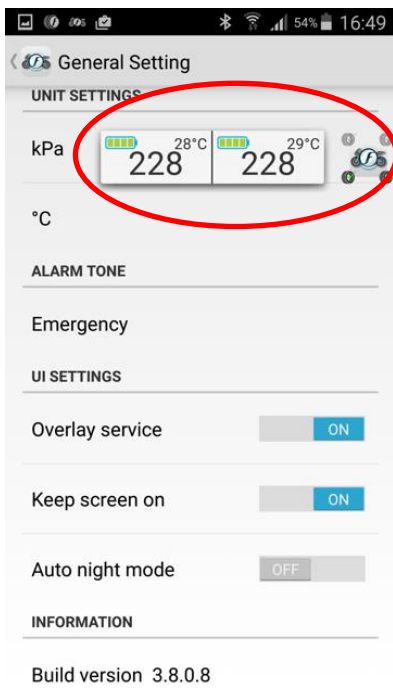
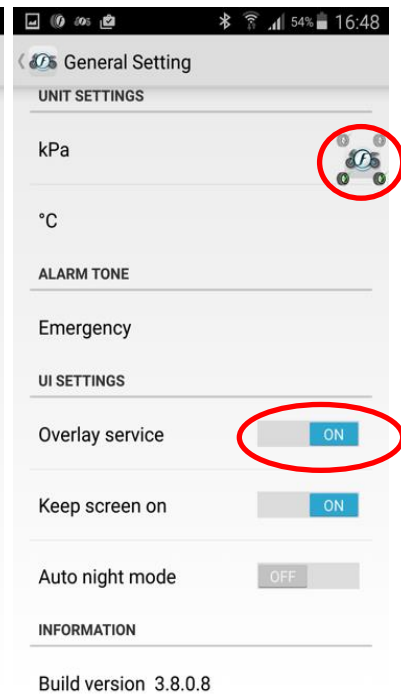
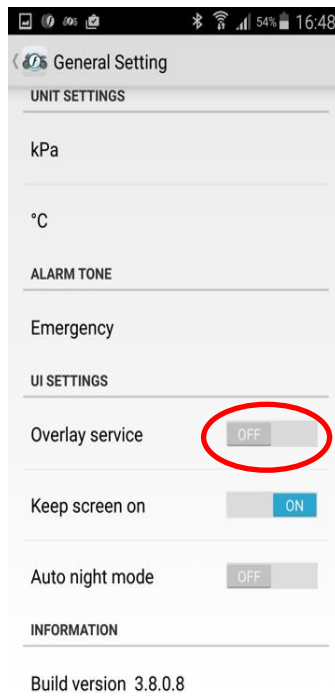
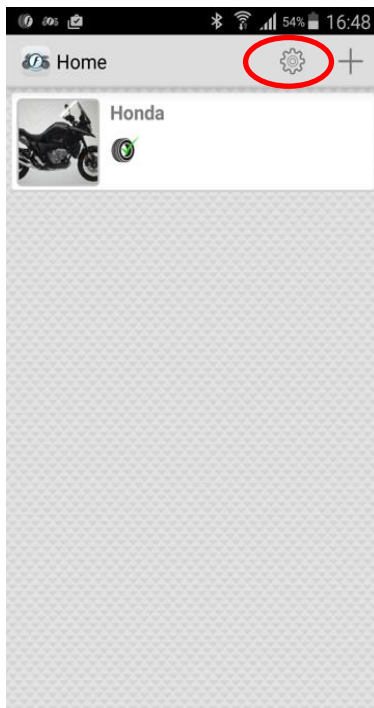

6 FOBO Tire Alert Messages

You will get the following alert messages on your smartphone during the operation of FOBO Bike under different breached conditions. When you receive an alert, please find a safe location to stop your bike and check the alert messages on the smartphone.

6.1 Pressure below preset limit

You will receive an alert when the tire pressure drops below 8%(first level alert – L1) or 15% (second level alert – L2) or 25%(third level alert – L3) of the Recommended pressure that you have set or at and below 30kPa(0.3bar/4.35psi). You can change this lower limit as shown in Section 5.8. For fuel economy and optimum tire performance, it is recommended to maintain this 8% range so that you can keep your tires inflated optimally. If you find the reminder is too frequent, you may want to check your tire for any leakage. Note that drastic temperature drop may also cause tire pressure drop. Please check your tire pressure and re-inflate during change of seasons.

6.2 Pressure above preset limit

You will receive an alert when the tire pressure increases beyond 25%(first level alert – L1) or 35% (second level alert – L2) or 45%(third level alert – L3) of the Recommended pressure that you have set or at and below 600kPa (6bar/87psi). You can change this upper limit as shown in Section 5.8. For optimum tire performance and grip, you should not overinflate your bike tires. Note that the tire pressure will naturally increase as the bike tires heat up due to friction while driving. However, you should check your tire in the event of an abnormal rise in the tire pressure.

6.3 Sensor battery level low

You will receive this alert when the sensor battery level drops to a certain level. Please change the battery immediately after you receive this alert. You will continue to receive this alert every time you start moving your bike until the battery is changed.

6.4 Pressure too low

You will receive this alert when the tire pressure drops below 25% of the Recommended pressure that you have set or below 30kPa(0.3bar/4.35psi), whichever is higher. This is third level(L3) alert which indicates that the tire pressure is critically low.

NOTE: IT IS DANGEROUS TO RIDE WITH LOW TIRE PRESSURE AND IT MAY LEAD TO A BLOW-OUT. PLEASE STOP THE BIKE AND HAVE THE TIRE CHECKED WHEN YOU RECEIVE THIS ALERT.

6.5 Pressure too high

You will receive this alert when the tire pressure is 45%(third level) above the Recommended pressure that you have set or beyond 600kPa(6bar/87psi), whichever is lower. This is third level(L3) alert which indicates that the tire pressure is critically high.

NOTE: THIS IS AN ABNORMAL RISE IN THE TIRE PRESSURE. PLEASE STOP THE BIKE AND HAVE THE TIRE CHECKED WHEN YOU RECEIVE THIS ALERT.

6.6 Temperature too high

You will receive this alert when the temperature detected exceeds 65°C/149°F. Note that the temperature inside the tire may be higher than the temperature detected by FOBO Bike sensors due to the air cooling effect on the tire valve when the bike is moving. It is extremely dangerous to ride when you get this alert message.

WARNING: WHEN YOU RECEIVE THIS ALERT, PLEASE STOP YOUR BIKE IMMEDIATELY AND CHECK THE TIRE!

6.7 Pressure Drop too fast

For fast air leak, FOBO Bike smartly alerts the user when it matters the most. FOBO sensors sense the pressure every **8 seconds**, if the pressure changes more than **15 Kpa OVER** this time frame, the sensor will immediately send an updated pressure signal to the phone which will trigger an alert on the FOBO Bike App in the event the pressure has breached the upper or lower limit (Applicable to all 3 alert levels).

If there is a sudden drop in pressure (say from **200 Kpa to 0 Kpa**) in **LESS than 8 seconds**, the App will not alert you because the App will treat this as though you have removed the sensor to inflate your tire. The system is designed this way as we believe that if there is an instant drop to 0 pressure, the user would have already felt it before getting any alert from the TPMS (like getting a burst, or hitting a kerb/drain, etc.)

Summary of Alerts:

Alarm Level	Trigger Point when threshold breached	Remarks	App Alerts
1st Level (L1)	8% below 25% above	Soft alerts	App will alert once and stop. When the user goes away from bike for 15min and return, the alert will recur for once and stop, so on and so forth. The alert will be triggered even when the App is in the background.
2nd Level (L2)	15% below 35% above	Emergency alerts	App will alert every 90 seconds until the user navigates to the Status page. The alert will then stop but will recur at 90sec interval after the user has left the bike for 15 minutes and return, even when the App is in background
3rd Level (L3)	25% below or at 30kPa and below 45% above or touching 600kPa	Emergency alerts	App will alert every 90 seconds until the user navigates to the Status page. The alert will then stop , and will recur at 90sec interval after the user has left the bike for 15 minutes and return, even when the App is in background
	Missing Sensor	Same as L2	Same as L2
	High Temperature (above 65 ^o C)	Same as L2	Same as L2
	Battery Low	Same as L1	Same as L1
Pressure drop too fast	Please Refer section 6.7 of this user manual		

WARNING: FOBO BIKE IS A MONITORING DEVICE TO ALERTS THE USER WHEN IT DETECTS SIGNALS THAT IS OUT OF PRE-SET CONDITIONS BASED ON THE SETTING BY THE USER. THE USER OR RIDER IS SOLELY RESPONSIBLE TO FIND OUT THE ACTUAL CONDITION OF THE TIRE AND TO ENSURE PROPER TIRE MAINTENANCE. FOBO TIRE IS NOT RESPONSIBLE FOR WRONG DIAGNOSTICS OR FALSE ALERTS THAT MAY CAUSE INCONVENIENCE.

7 Replacing Battery

The coin cell battery (CR2032) used in the FOBO Bike sensors could last up to two years based on normal operating condition. Operating in extreme cold or hot temperatures may reduce battery operating life for the tire sensors.

You will receive an alert on the smartphone when the sensor battery levels are low. You will be alerted every time you start to ride your bike until the battery is replaced. It is advisable to change the battery once you receive this battery alert to ensure proper performance of FOBO Bike. Do not wait until the battery is fully drained as it will cause FOBO Bike to stop working properly.

To replace the battery of sensor unit, unscrew the top cover. Be careful not to damage the rubber gasket as it may affect water resistance of the sensor unit. Ensure the battery (CR2032) is inserted with the “+” sign facing up, away from the PCB.

WARNING: RE-USING OLD BATTERIES MAY DAMAGE THE ELECTRONICS.

8 Trouble Shooting Guide

- Could not sign up a new FOBO account (did not receive activation e-mail)
 - Check the e-mail address entry is typed correctly
 - Check the Spam mailbox, in case the e-mail was filtered by the e-mail server
 - Check the smartphone is connected to internet and able to receive e-mail
- Could not sign up a new FOBO account (received activation e-mail)
 - Make sure to click on the “Activation” link of the latest e-mail, in case there are multiple authentication e-mails

- You should be directed to web page that clearly displayed “FOBO account is activated”.
- Unable to Login after signing up to FOBO App
 - Make sure your e-mail address is typed correctly
 - A verification mail will be sent to your e-mail address
 - Follow the instruction in the mail to activate your account before you can Login
 - Check if internet connection is available on your smartphone
- Unable to pair FOBO Bike sensors
 - Make sure the sensor is screwed onto a tire valve with pressure above 100kPa
 - Try unscrew the sensor from tire valve, screw it back and try again
 - Make sure the battery is installed correctly with battery “+” on top.
 - Make sure your smartphone has Bluetooth 4.0 (Smart Ready) capability.
NOTE: BLUETOOTH 2.0 OR 3.0 WILL NOT WORK WITH THIS DEVICE.
 - Try to reset the Bluetooth manager of your smartphone (for iOS: Settings-> Bluetooth-> OFF->ON). At times the Bluetooth manager may be disrupted which may require manual reset.
 - Try to do a hard reset on the phone.

9 FOBO Bike Specifications

- **Bluetooth:** v4.0
- **Supported profiles:** GAP, GATT attributes, Device Information Service, Proximity Reporter, Battery Service
- **Transmit Conducted Power:** +4.0dBm (sensor)
- **Receiver Sensitivity:** -93dBm@0.1%BER
- **Antenna Return Loss:** -12dB
- **Operating Frequency:** 2.4 GHz
- **Weight:** ~11.5g (sensor – with battery)
- **Sensor Dimension H x D:** 15mm x 26mm
- **Maximum Pressure:** 600kPa (87psi)
- **Battery Type:** CR2032 (sensor) Operating life up to two years. (**NOTE: The battery operating life varies according to usage and climate temperature**)
- **Operating Temperature:** -40°C to 85°C(sensor)
- **ESD:** 8kV air, 4kV direct contact
- **Operating Humidity:** up to 90% non-condensing at 40°C
- **Dust and Water Proof:** IEC60529 compliant to IP57(sensor)

- **Sensor structural threshold:** 350N ball pressure intensity test
- **Mechanical & Environmental Reliability Testing Standards:** IEC 60068-2-2, IEC 60068-2-1, ISO 21750, IEC 60068-2-29, IEC 60068-2-5, IEC 60068-2-32, ISO 15184, ISO 2409

10 Warning

- Take note that FOBO Bike is not meant to function as anti-accident or anti-injury device. FOBO Bike is not a substitute for safe tire maintenance practices. Please take full responsibility of your own safety while riding. And continue to send your bike for regular tire check and maintenance.
- You shall not use the FOBO Bike in any unlawful way that violates any laws.
- Avoid exposing the FOBO Bike sensors to solvent, fire or extreme temperatures.
- FOBO Bike may fail to function properly if the battery is below optimum level. Replace the battery immediately to continue enjoying full features of FOBO Bike.

CAUTION

THERE MAY BE A RISK OF EXPLOSION IF BATTERY IS REPLACED BY AN INCORRECT TYPE. DISPOSE ALL USED BATTERIES PROPERLY.

11 Regulatory Information

Federal Communication Commission Interference Statement

This device complies with Part 15 of the FCC Rules. Operation is subject to the following two conditions: (1) This device may not cause harmful interference, and (2) this device must accept any interference received, including interference that may cause undesired operation.

This equipment has been tested and found to comply with the limits for a Class B digital device, pursuant to Part 15 of the FCC Rules. These limits are designed to provide reasonable protection against harmful interference in a residential installation. This equipment generates, uses and can radiate radio frequency energy

and, if not installed and used in accordance with the instructions, may cause harmful interference to radio communications. However, there is no guarantee that interference will not occur in a particular installation. If this equipment does cause harmful interference to radio or television reception, which can be determined by turning the equipment off and on, the user is encouraged to try to correct the interference by one of the following measures:

- Reorient or relocate the receiving antenna.
- Increase the separation between the equipment and receiver.
- Connect the equipment into an outlet on a circuit different from that to which the receiver is connected.
- Consult the dealer or an experienced radio/TV technician for help.

FCC Caution: Any changes or modifications not expressly Approved by the party responsible for compliance could void the user's authority to operate this equipment.

This transmitter must not be co-located or operating in conjunction with any other antenna or transmitter.

Radiation Exposure Statement:

This equipment complies with FCC radiation exposure limits set forth for an uncontrolled environment. This equipment should be installed and operated with minimum distance 20cm between the radiator & your body.

Industry Canada statement:

This device complies with RSS-210 of the Industry Canada Rules. Operation is subject to the following two conditions: (1) This device may not cause harmful interference, and (2) this device must accept any interference received, including interference that may cause undesired operation.

Ce dispositif est conforme à la norme CNR-210 d'Industrie Canada Applicable aux Appareils radio exempts de licence. Son fonctionnement est sujet aux deux conditions suivantes: (1) le dispositif ne doit pas produire de brouillage préjudiciable, et (2) ce dispositif doit accepter tout brouillage reçu, y compris un brouillage susceptible de provoquer un fonctionnement indésirable.

Radiation Exposure Statement:

This equipment complies with IC radiation exposure limits set forth for an uncontrolled environment. This equipment should be installed and operated with minimum distance 20cm between the radiator & your body.

Déclaration d'exposition aux radiations:

Cet équipement est conforme aux limites d'exposition aux rayonnements IC établies pour un environnement non contrôlé. Cet équipement doit être installé et utilisé avec un minimum de 20 cm de distance entre la source de rayonnement et votre corps.

European Union Regulatory Conformance

This equipment is CE marked according to the provisions of the R&TTE Directive (99/5/EC) and is in compliance with the essential requirements and other relevant provisions of the Directive 1999/5/EC. This equipment meets the following conformance standards:

EN 300 328, EN62479, EN 301 489-1&17, EN 60950-1

EU Declaration of Conformity

Hereby, Salutica Allied Solutions Sdn. Bhd. declares that this Bluetooth device is in compliance with the essential requirements and other relevant provision of Directive 1999/5/EC.

Caution: Changes or modifications to this **FOBO** device not expressly Approved by the party responsible for compliance could void the user's authority to operate it.

Bluetooth Wireless Compatibility:

This **FOBO** device supports the following Bluetooth wireless protocols and profiles:

- Bluetooth core technology v4.0
- Battery Profile (BAS)
- Proximity (PXP)
- Device Information Service (DIS)

Bluetooth Wireless Interoperability:

This **FOBO** device is designed to be interoperating with all Bluetooth wireless products that support compatible profiles and roles including:

- Bluetooth core technology v4.0
- Bluetooth master and slave roles

NCC Statement 低功率電波輻射性電機管理辦法

第十二條 經型式認證合格之低功率射頻電機，非經許可，公司、商號或使用者均不得擅自變更頻率、加大功率或變更原設計之特性及功能。

第十四條 低功率射頻電機之使用不得影響飛航安全及干擾合法通信；經發現有干擾現象時，應立即停用，並改善至無干擾時方得繼續使用。前項合法通信，指依電信法規定作業之無線電通信。低功率射頻電機須忍受合法通信或工業、科學及醫療用電波輻射性電機設備之干擾。

12 Intellectual Properties

- FOBO™ is a trademark of Salutica Allied Solutions Sdn Bhd. All rights reserved.
- FOBO™ Tire incorporates a few patent pending technologies solely owned by Salutica Allied Solutions Sdn Bhd.
- Bluetooth® is a registered trademark owned by Bluetooth SIG Inc.
- iPhone® is a registered trademark of Apple Inc.

13 Limited Warranty & Disclaimer

13.1 Warranty

FOBO Bike comes with a 12 months limited warranty. This Limited Warranty does not cover: 1) products purchased from an unauthorized reseller; 2) products purchased through online auctions; 3) products that are operated in combination with software, peripheral or ancillary equipment such as but not limited to batteries, chargers, adapters, headsets, connector cables, and power supplies ("Ancillary Equipment") not furnished or otherwise certified by Salutica for use with the FOBO products or any damage to the FOBO products or ancillary equipment as a result of such use; 4) damage caused by (a) accident, fire, misuse, neglect, unusual physical or electrical stress, or modification; (b) improper or unauthorized installation, wiring, repair, testing or (c) use of the product outside Salutica's published guidelines; 5) instances in which someone other than Salutica (or its authorized service centers) tests, alters, modifies or services the products in any way; 6) products that have (a) serial numbers or date tags that have been removed or altered, or (b) nonconforming or non-FOBO housings or parts; and 7) consumable spare parts and accessories (unless they are found to be non-functional or broken upon purchase of product).

In order to obtain any warranty service, you agree to bear all shipping charges of the FOBO Bike device to Salutica's address.

13.2 Disclaimer

SALUTICA MAKES NO OTHER EXPRESS WARRANTY WHETHER WRITTEN OR ORAL AND SALUTICA EXPRESSLY DISCLAIMS ALL WARRANTIES AND CONDITIONS NOT STATED IN THIS LIMITED WARRANTY. TO THE EXTENT ALLOWED BY THE LOCAL LAW OF JURISDICTIONS OUTSIDE MALAYSIA, SALUTICA DISCLAIMS ALL IMPLIED WARRANTIES OR CONDITIONS, INCLUDING ANY IMPLIED WARRANTIES OF MERCHANTABILITY AND FITNESS FOR A PARTICULAR PURPOSE. FOR ALL TRANSACTIONS OCCURRING IN MALAYSIA, ANY IMPLIED WARRANTY OR CONDITION OF MERCHANTABILITY, SATISFACTORY QUALITY, OR FITNESS FOR A PARTICULAR PURPOSE IS LIMITED TO THE WARRANTY PERIOD AS PROVIDED BY SALUTICA IN THE MATERIALS RECEIVED AT THE TIME OF PURCHASE.

No warranty is made that the software provided by Salutica will meet your requirements or will work in combination with any hardware or Applications software products provided by third parties, that the operation of the software products will be uninterrupted or error free, or that all defects in the software products will be corrected.

13.3 Limitation of Liability

THE MAXIMUM LIABILITY OF SALUTICA UNDER THIS LIMITED WARRANTY IS EXPRESSLY LIMITED TO THE LESSER OF THE PRICE YOU HAVE PAID FOR THE PRODUCT OR THE COST OF REPAIR OR REPLACEMENT OF THAT PRODUCT OR ANY COMPONENT OR PART THAT MALFUNCTION IN CONDITIONS OF NORMAL USE. EXCEPT AS INDICATED ABOVE, IN NO EVENT WILL SALUTICA BE LIABLE FOR ANY DAMAGES CAUSED BY THE FOBO BIKE PRODUCT OR THE FAILURE OF THE PRODUCT TO PERFORM, INCLUDING ANY LOST PROFITS OR SAVINGS OR SPECIAL, INCIDENTAL, OR CONSEQUENTIAL DAMAGES. SALUTICA IS NOT LIABLE FOR ANY CLAIM MADE BY A THIRD PARTY OR MADE BY YOU FOR A THIRD PARTY. THIS LIMITATION OF LIABILITY APPLIES WHETHER DAMAGES ARE SOUGHT, OR A CLAIM MADE, UNDER THIS LIMITED WARRANTY OR AS A TORT CLAIM (INCLUDING NEGLIGENCE AND STRICT PRODUCT LIABILITY), A CONTRACT CLAIM, OR ANY OTHER CLAIM. THIS LIMITATION OF LIABILITY CANNOT BE WAIVED OR AMENDED BY ANY PERSON. THIS LIMITATION OF LIABILITY WILL BE EFFECTIVE EVEN IF YOU HAVE ADVISED SALUTICA OR AN AUTHORIZED REPRESENTATIVE OF SALUTICA OF THE POSSIBILITY OF ANY SUCH DAMAGES. THIS LIMITATION OF LIABILITY, HOWEVER, WILL NOT APPLY TO CLAIMS FOR PERSONAL INJURY.

13.4 What Law Governs This Warranty

THIS LIMITED WARRANTY IS GOVERNED BY AND CONSTRUED UNDER THE LAWS OF MALAYSIA.